



Parallelweg 12,
5121 LD RIJEN
info@hamerenhark.nl
+ 31(0)626764231

KvK: 18080497
B.T.W. nummer: NL172018055B02
IBAN: NL83RABO0117571776

PROJECT:

HH2 COMFORT/AFRIKA

TEKENINGSET: WO.01

Inhoud: Situatie
 ISO HSB
 Details

OPDRACHTGEVER
LOCATIE
STATUS
EENHEID
DATUM

Beekse Bergen
Hilvarenbeek
concept
mm
14/03/2017



situatie

SCHAAL:

1:1000



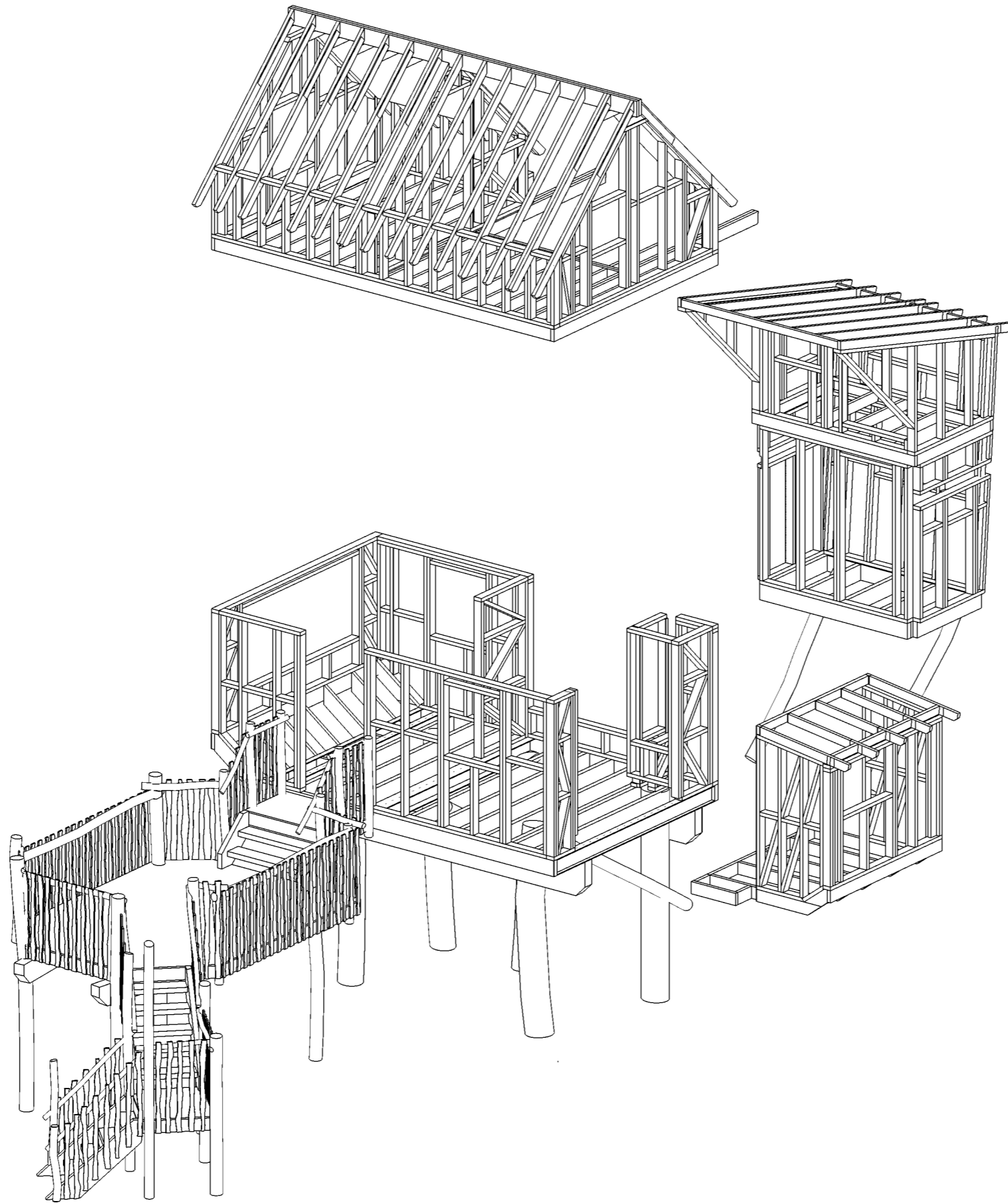

exploded view HSB
SCHAAL: -

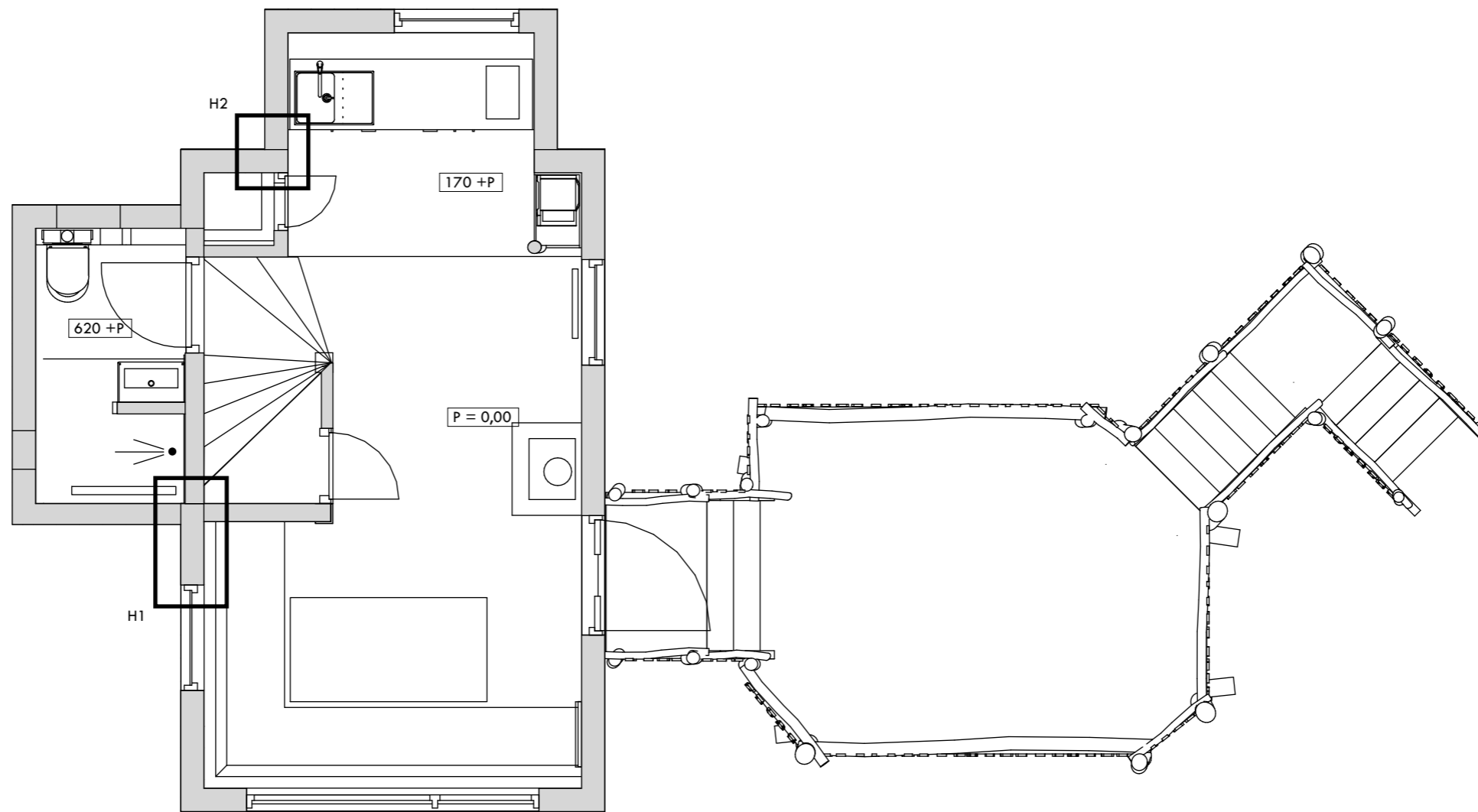

begane grond

SCHAAL:

1:50

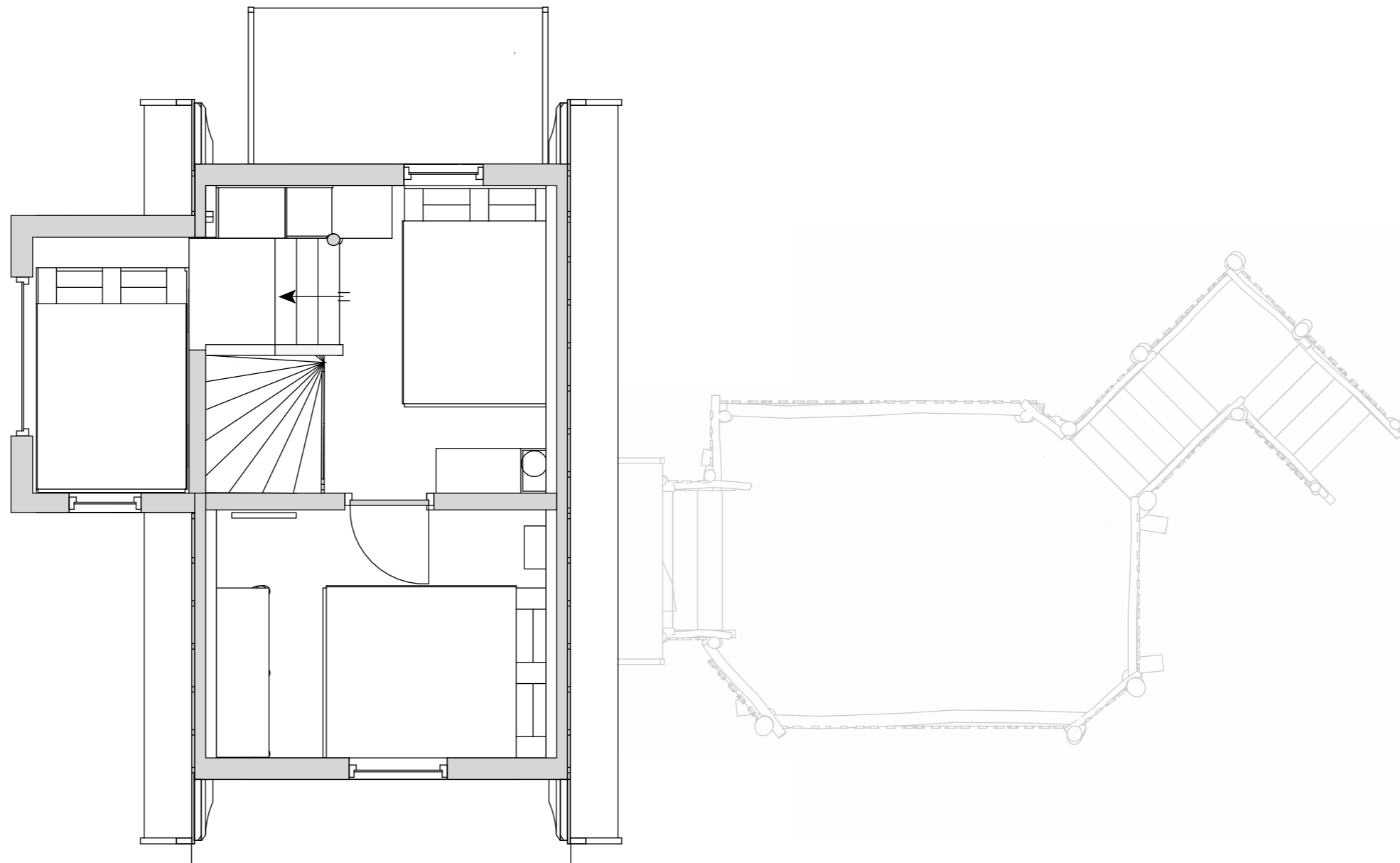

eerste verdieping
SCHAAL: 1:50





vooraanzicht

SCHAAL:

1:50



linker zijaanzicht
SCHAAL: 1:50



achteraanzicht

SCHAAL: 1:50



rechter zijaanzicht
SCHAAL: 1:50

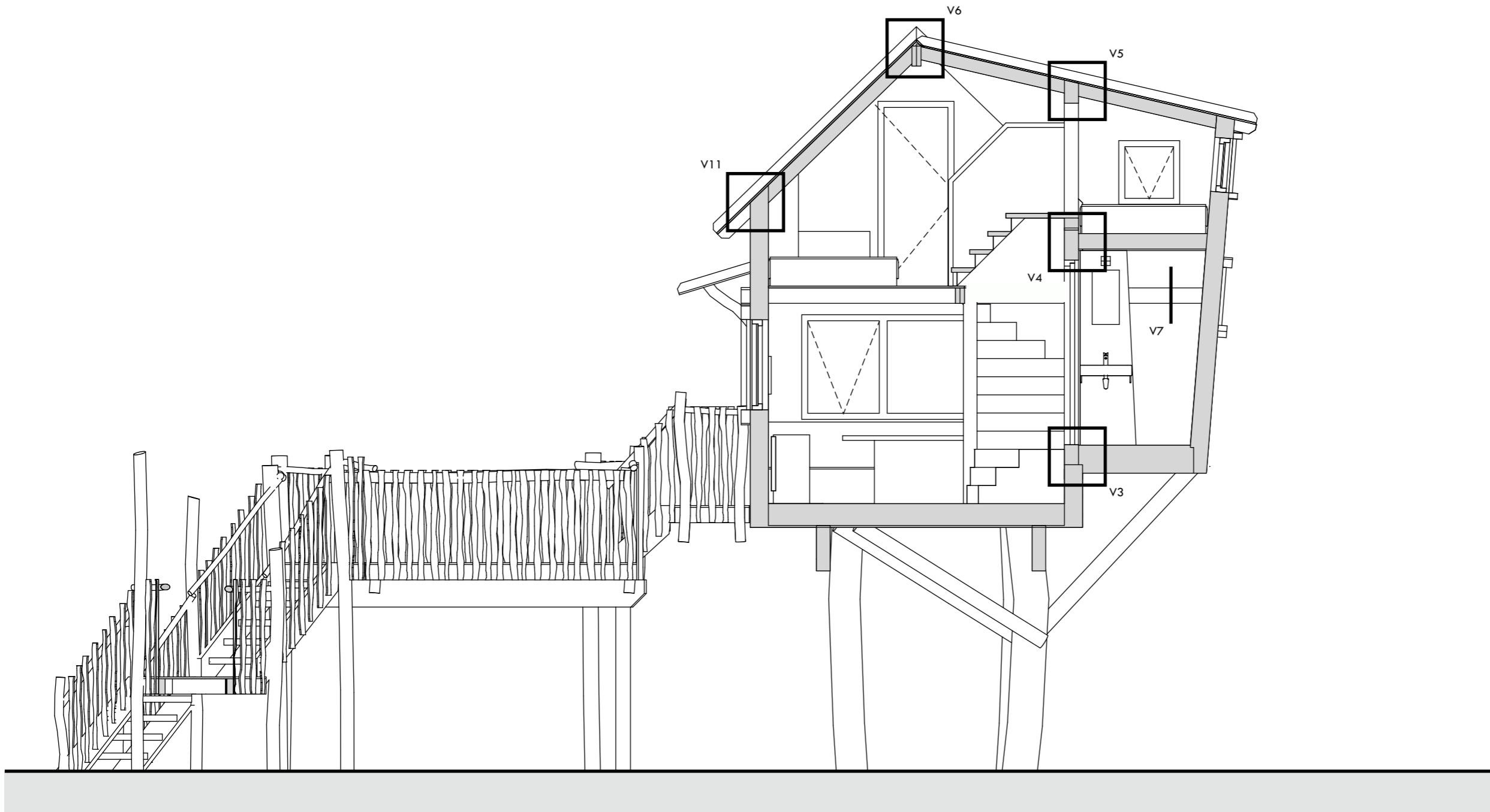

doorsnede AA'
SCHAAL: 1:50

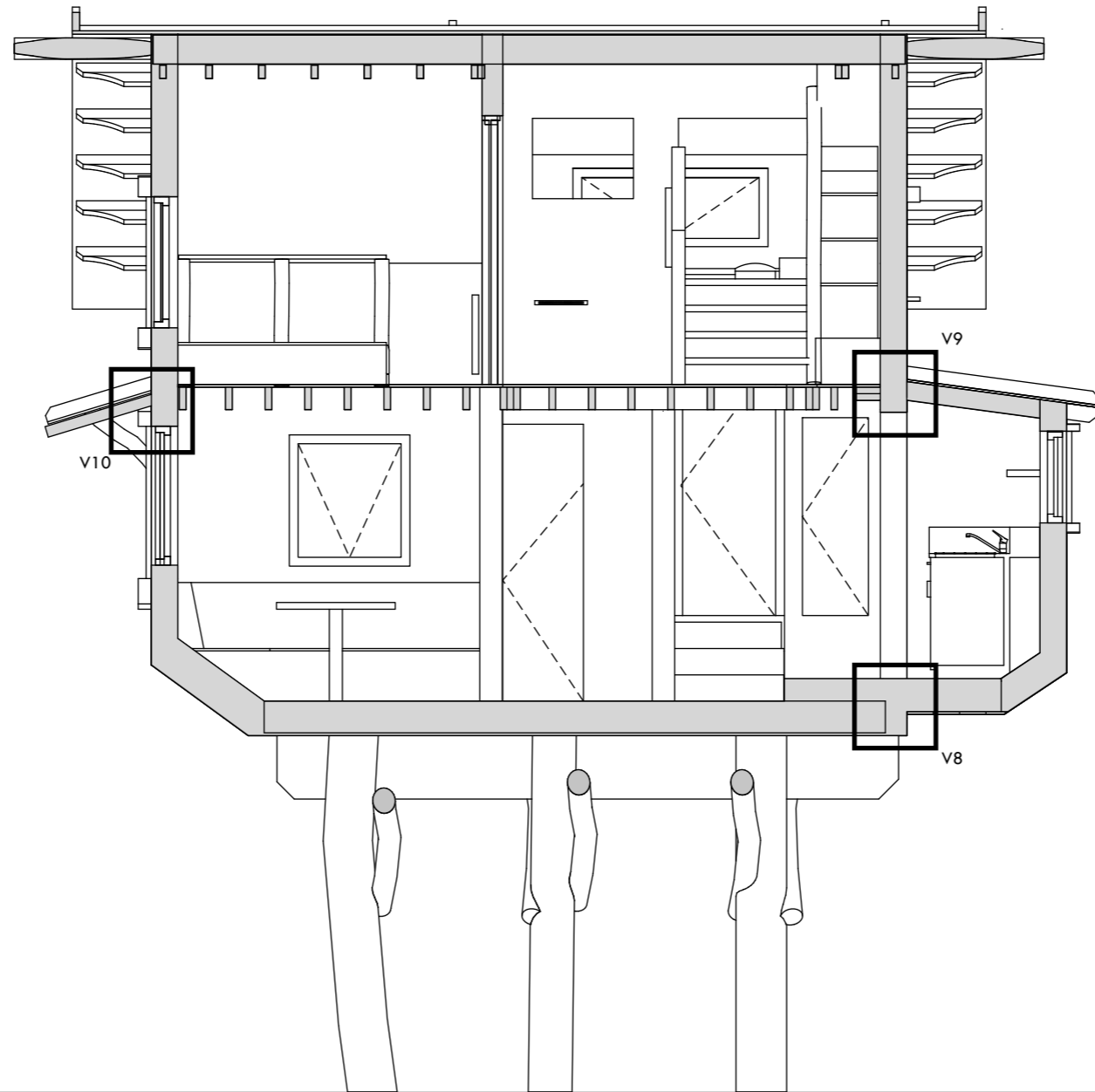

doorsnede BB'
SCHAAL: 1:50



202
18
120
20 22 22



compriband

buitenwand
 - 18mm multiplex
 - dampkerende folie
 - HSB 120mm x 50mm h.o.h. 600mm,
 120mm steenwol
 - waterkerende dampdoorlatende folie
 - dubbel raggelwerk 45mm x 22mm h.o.h. 300mm
 - douglas mes en groef gevelbekleding 20mm

binnenwand
 - 18mm multiplex
 - HSB 120mm x 50mm h.o.h. 950mm
 - 18mm multiplex

buitenwand
 - 18mm multiplex
 - dampkerende folie
 - HSB 120mm x 50mm h.o.h. 600mm,
 120mm steenwol
 - waterkerende dampdoorlatende folie
 - dubbel raggelwerk 45mm x 22mm h.o.h. 300mm
 - douglas mes en groef gevelbekleding 20mm

Overlap folies tapen

aluminium hoekprofiel

Overlap folies tapen

H1
 SCHAAL: 1:5

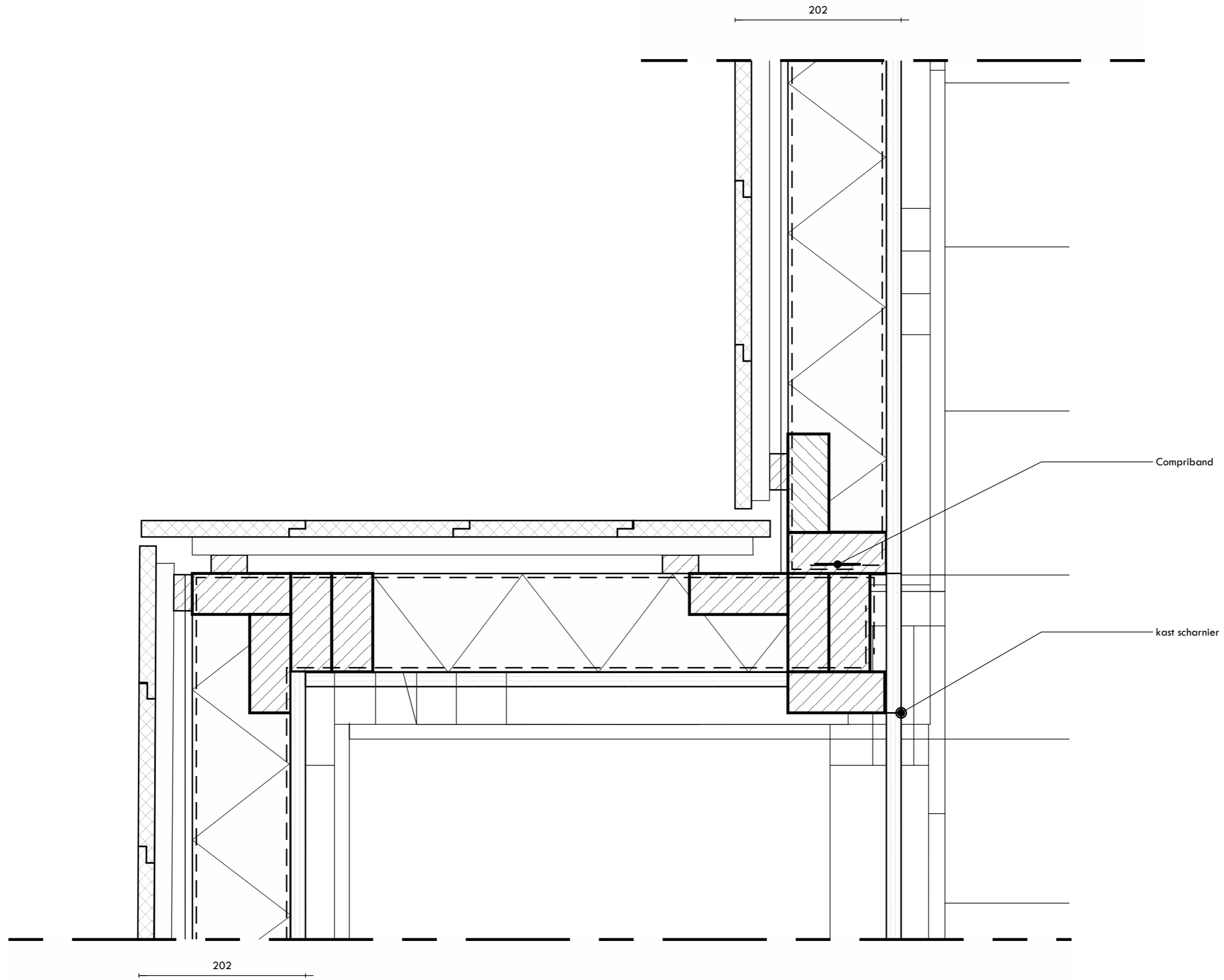

H2
 SCHAAL:

1:5

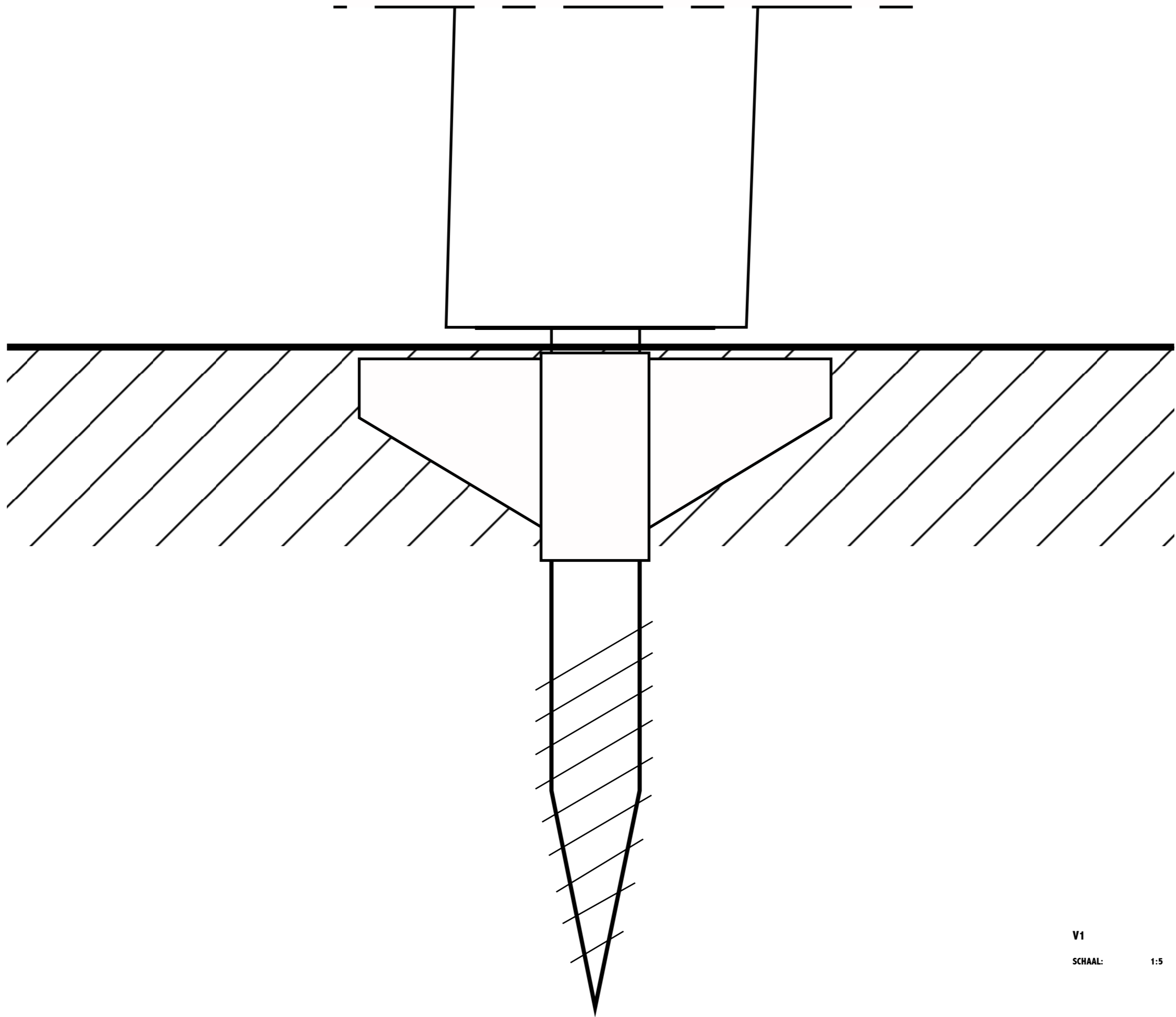

V1
SCHAAL:

1:5

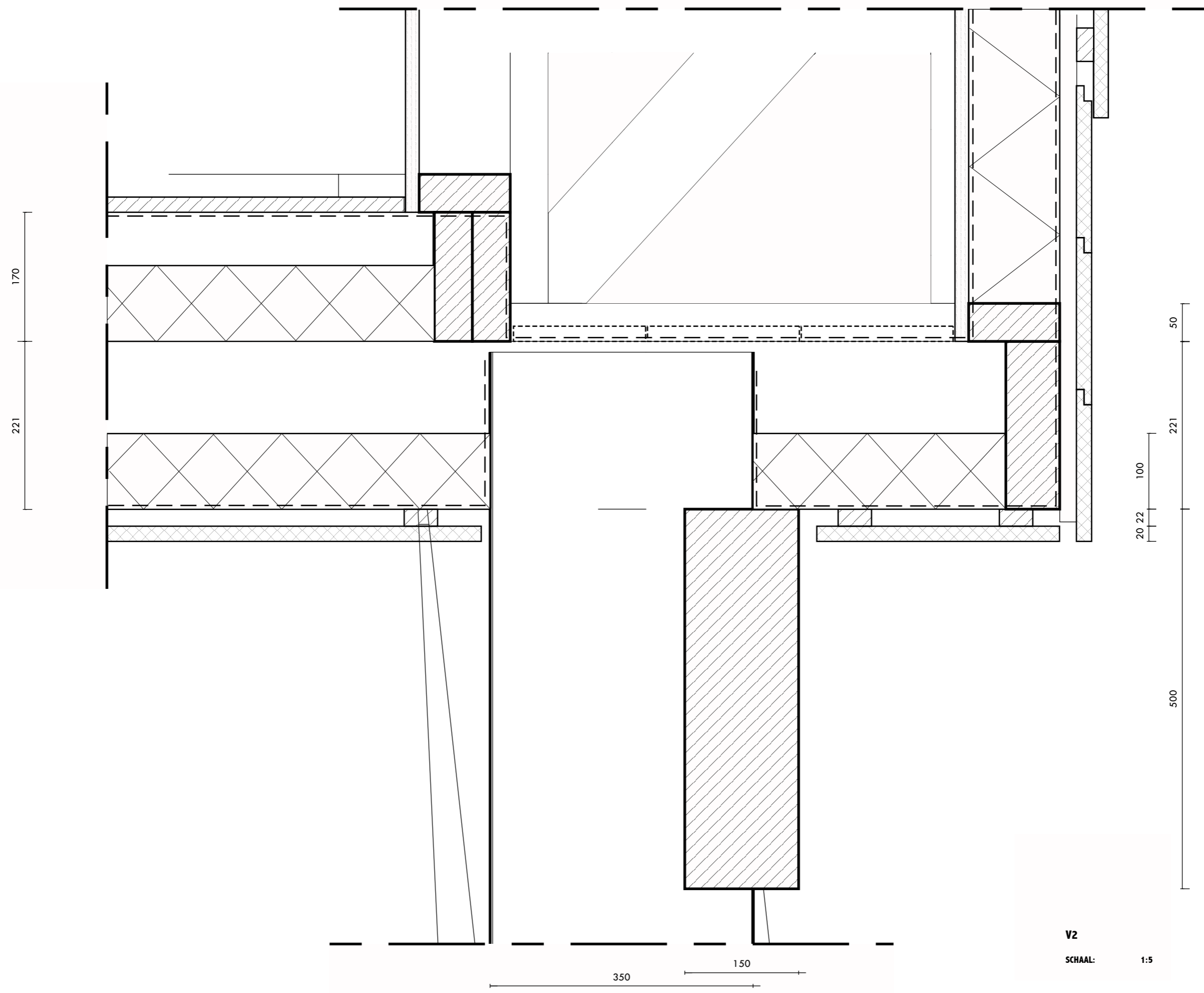

V2
SCHAAL:

1:5

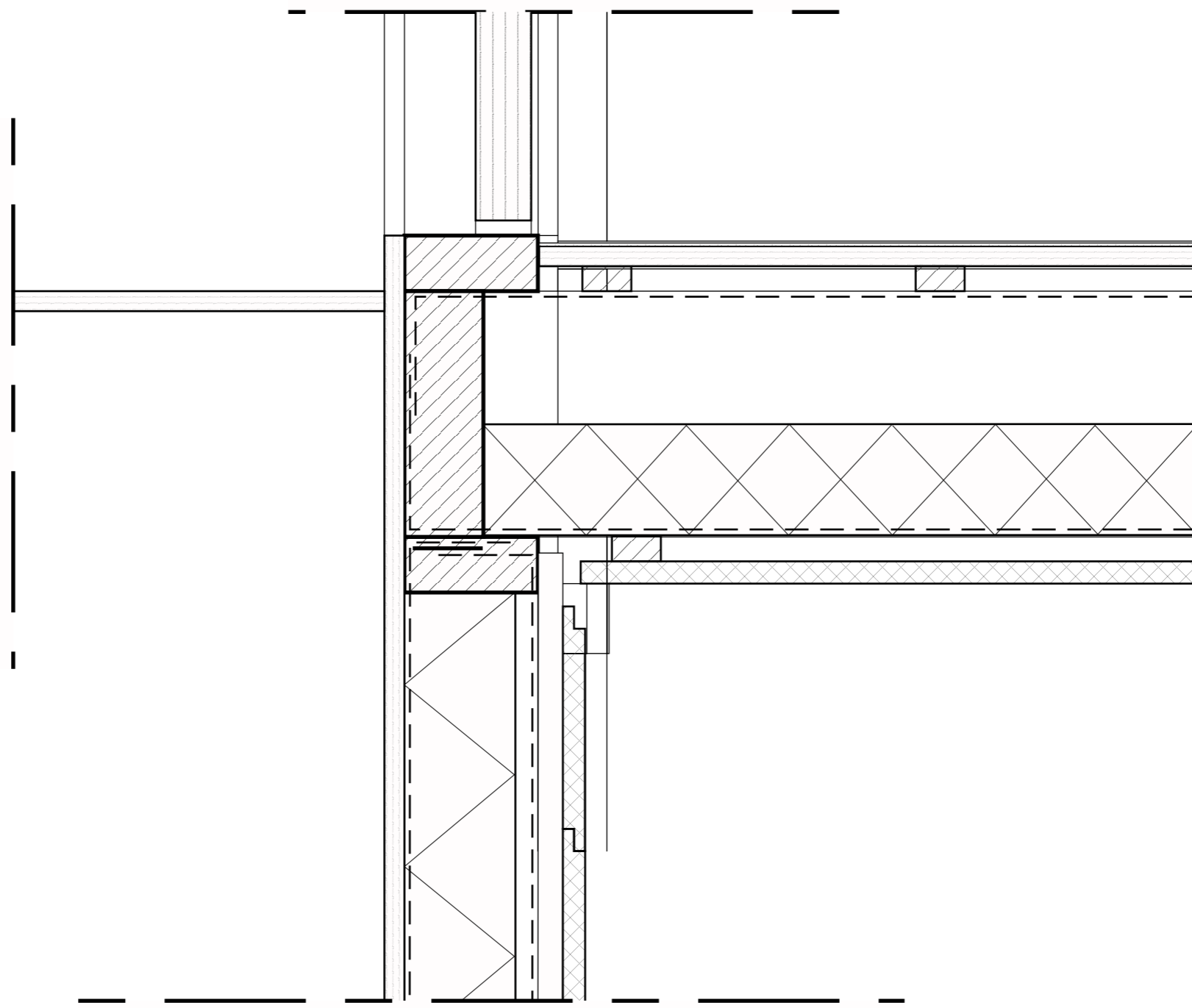

V3

SCHAAL:

1:5

schoepen ventilatierooster

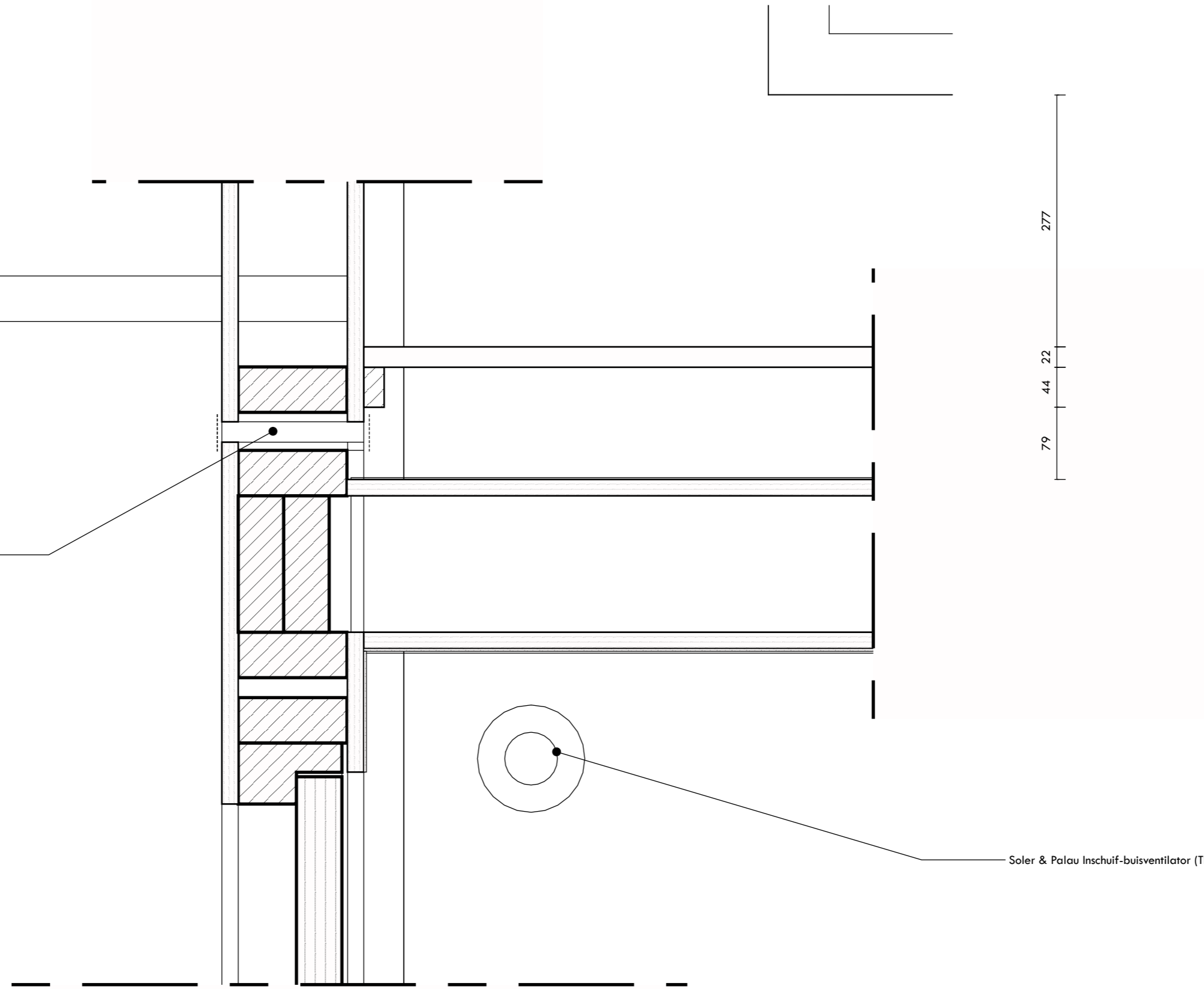

Soler & Palau Inschuif-buisventilator (TDM200) - Ø 120mm

V4

SCHAAL:

1:5

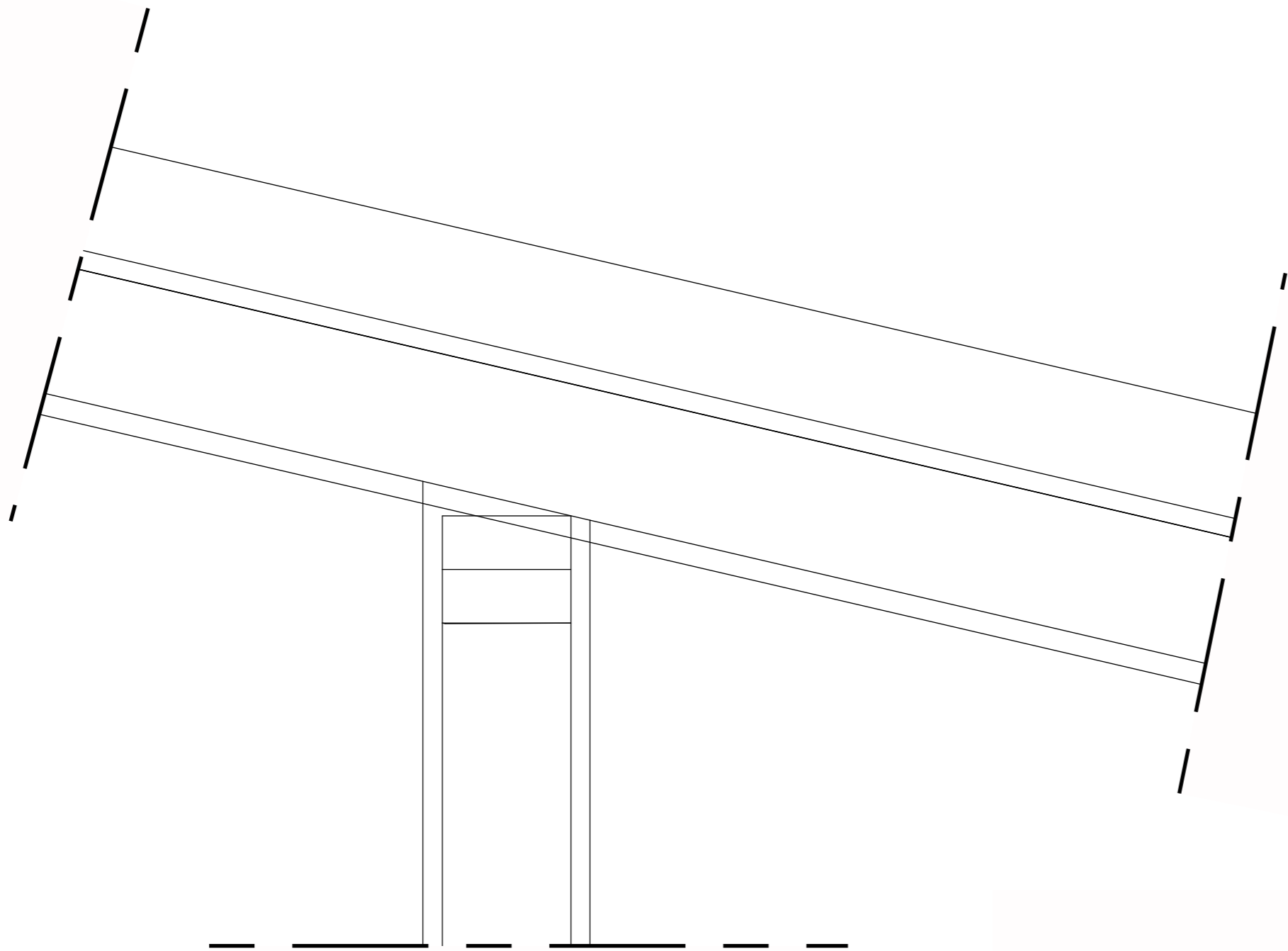

V5
SCHAAL:

1:5

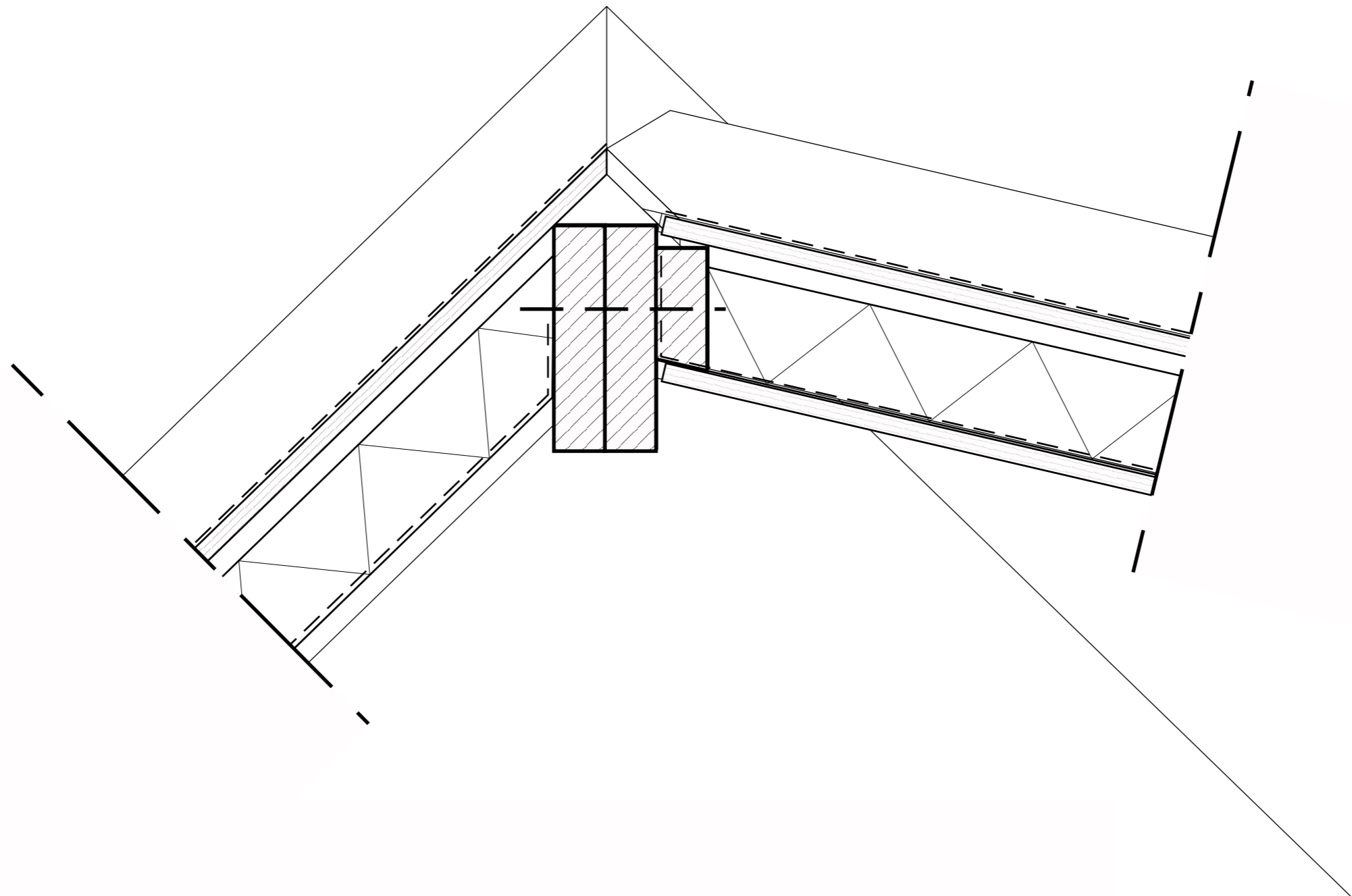

V6

SCHAAL:

1:5

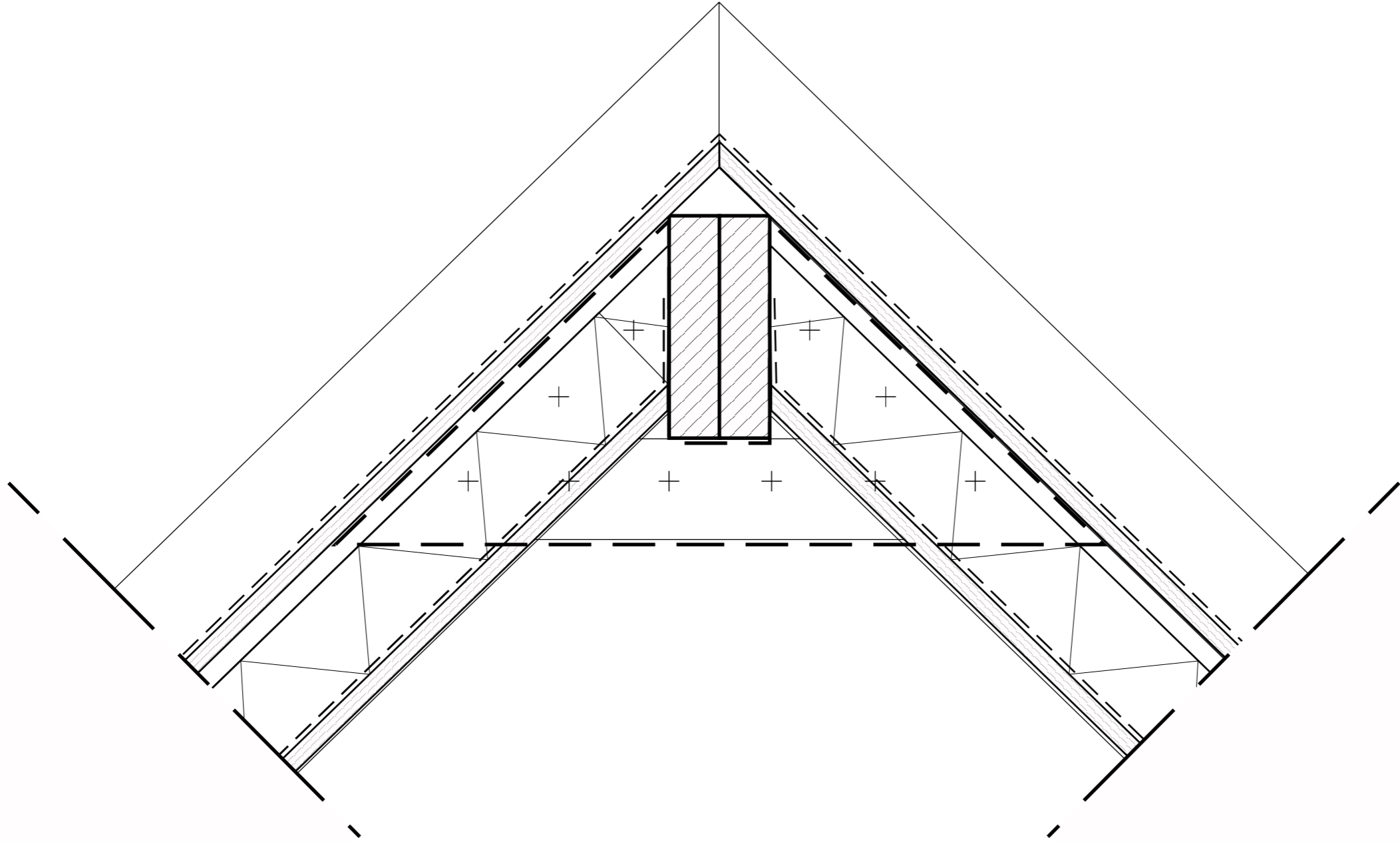

V6

SCHAAL:

1:5

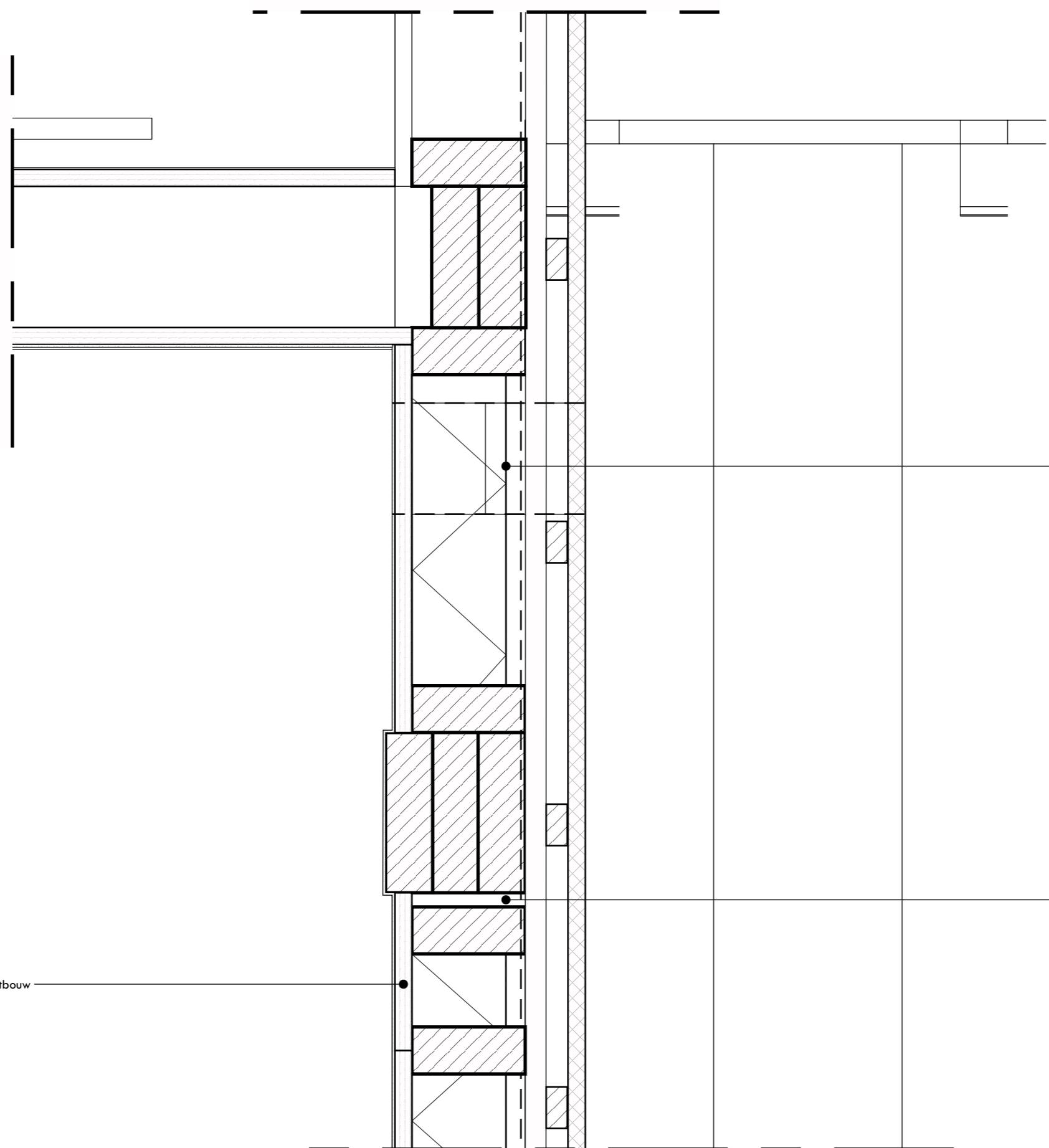

buisventilator

stelruimte, uitvullen na bevestiging uitbouw

afdekplaat aanbrengen na bevestiging uitbouw

V7
SCHAAL:

1:5

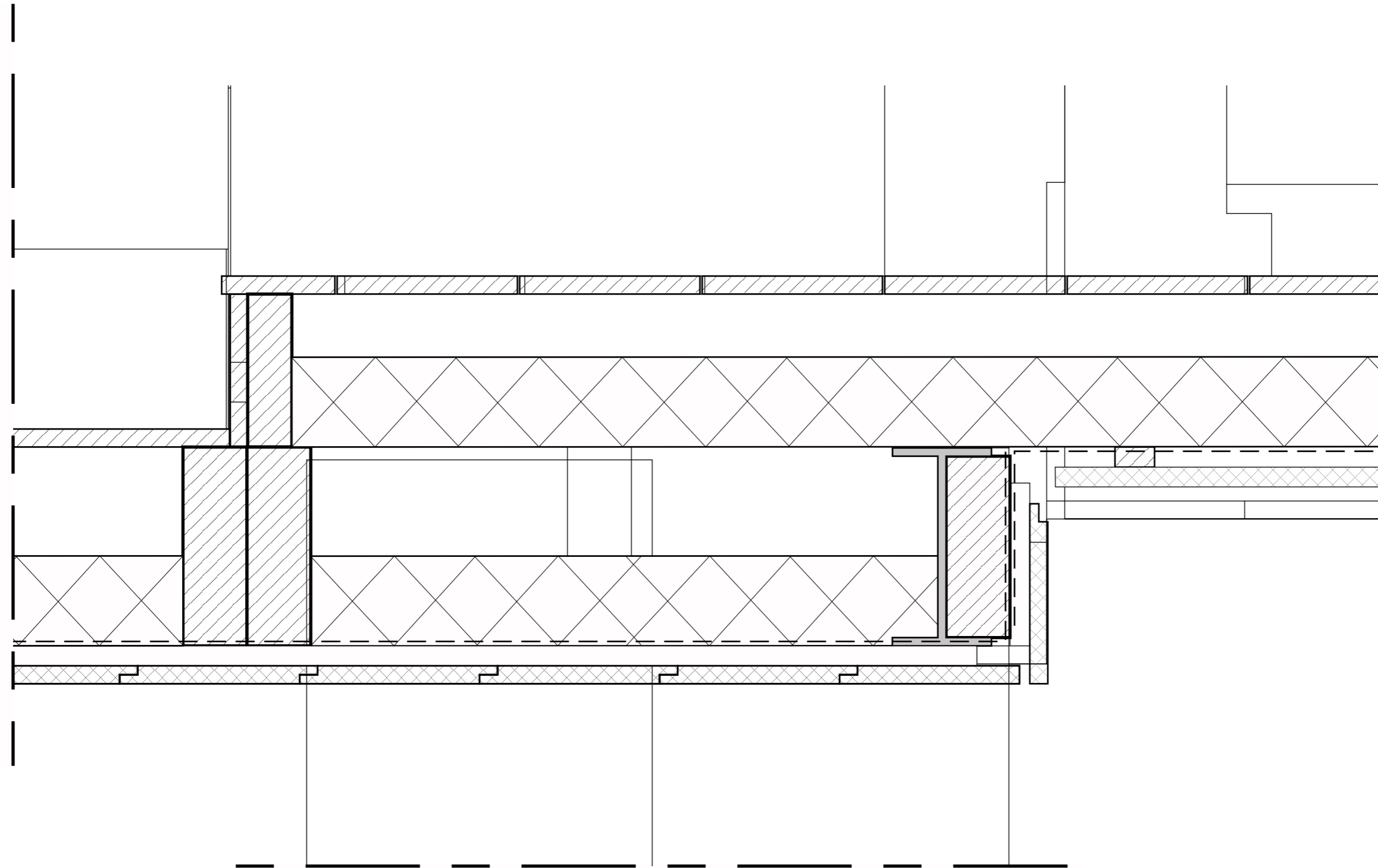

V8

SCHAAL:

1:5

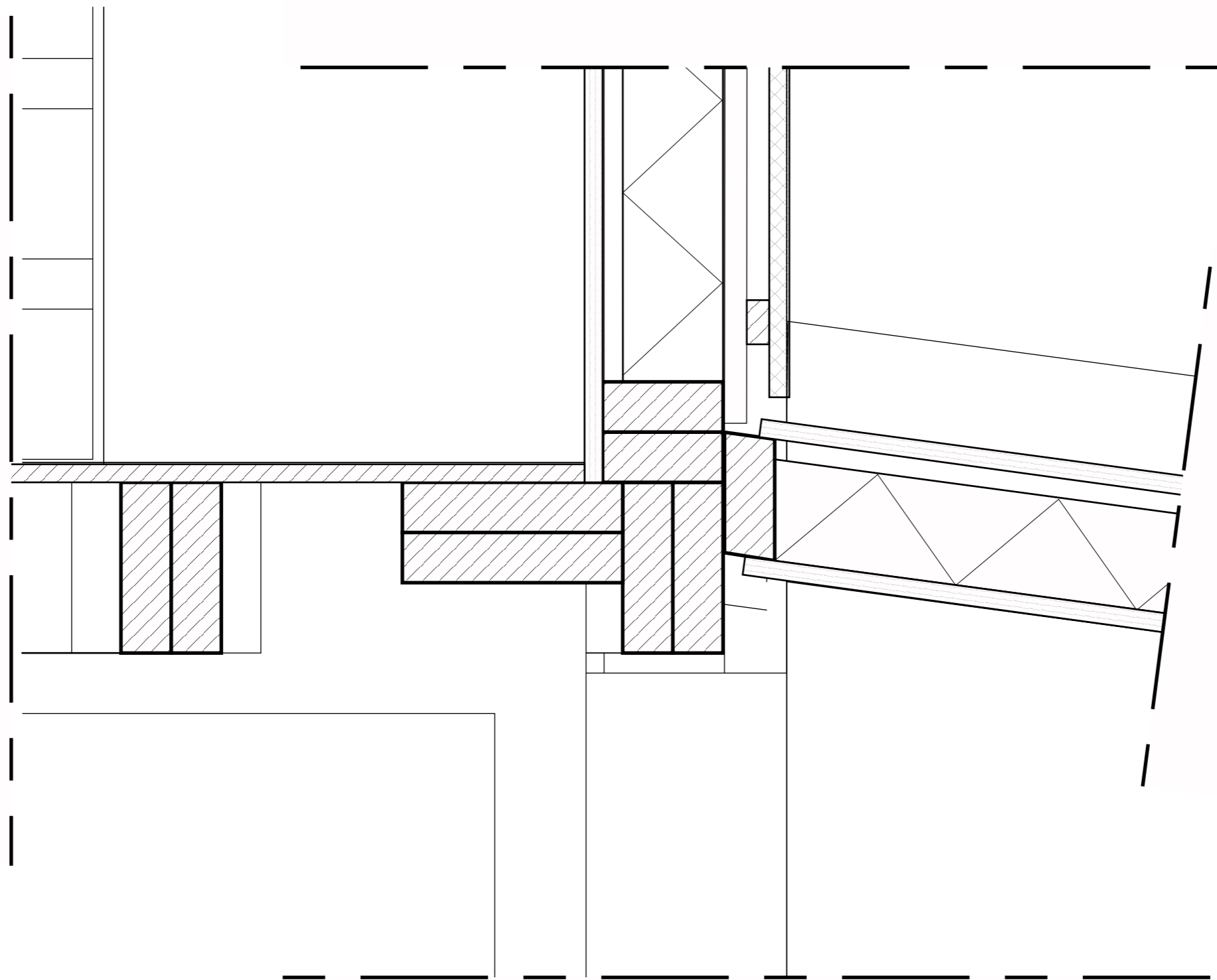

V9

SCHAAL:

1:5

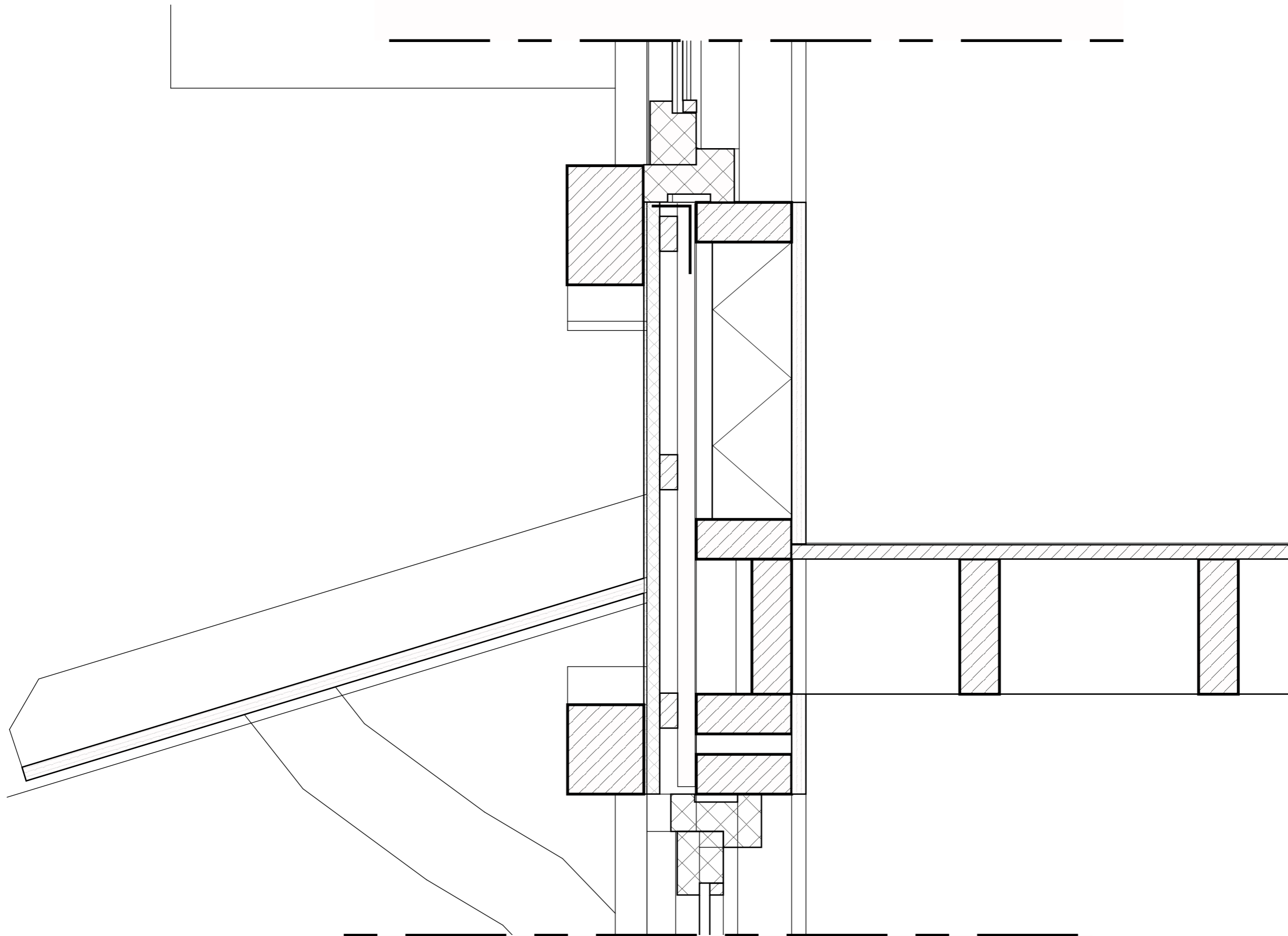

V10

SCHAAL:

1:5

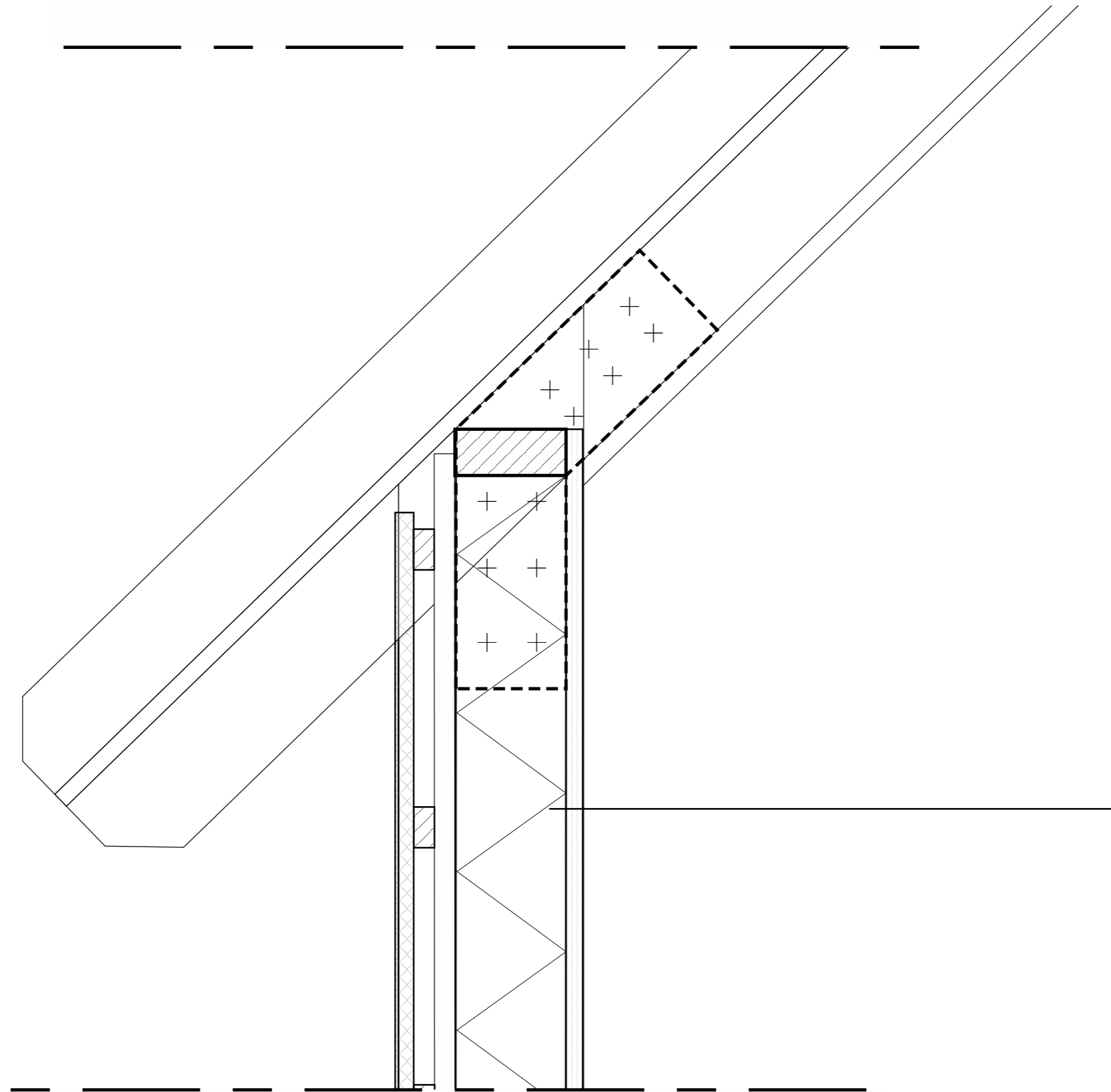

V11
SCHAAL:

1:5